



# Common Mode Filters

For power line

**ACP Series**

# ACP3225 Type

---

**ACP3225**

**[1210 inch]\***

\* Dimensions Code JIS[EIA]

## REMINDERS FOR USING THESE PRODUCTS

Before using these products, be sure to request the delivery specifications.

### SAFETY REMINDERS

Please pay sufficient attention to the warnings for safe designing when using these products.

#### REMINDERS

- The storage period is less than 6 months. Be sure to follow the storage conditions (Temperature: 5 to 40°C, Humidity: 10 to 75% RH or less).  
If the storage period elapses, the soldering of the terminal electrodes may deteriorate.
- Do not use or store in locations where there are conditions such as gas corrosion (salt, acid, alkali, etc.).
- Before soldering, be sure to preheat components.  
The preheating temperature should be set so that the temperature difference between the solder temperature and chip temperature does not exceed 150°C.
- Soldering corrections after mounting should be within the range of the conditions determined in the specifications.  
If overheated, a short circuit, performance deterioration, or lifespan shortening may occur.
- When embedding a printed circuit board where a chip is mounted to a set, be sure that residual stress is not given to the chip due to the overall distortion of the printed circuit board and partial distortion such as at screw tightening portions.
- Self heating (temperature increase) occurs when the power is turned ON, so the tolerance should be sufficient for the set thermal design.
- Carefully lay out the coil for the circuit board design of the non-magnetic shield type.  
A malfunction may occur due to magnetic interference.
- Use a wrist band to discharge static electricity in your body through the grounding wire.
- Do not expose the products to magnets or magnetic fields.
- Do not use for a purpose outside of the contents regulated in the delivery specifications.
- The products listed on this catalog are intended for use in general electronic equipment (AV equipment, telecommunications equipment, home appliances, amusement equipment, computer equipment, personal equipment, office equipment, measurement equipment, industrial robots) under a normal operation and use condition.  
The products are not designed or warranted to meet the requirements of the applications listed below, whose performance and/or quality require a more stringent level of safety or reliability, or whose failure, malfunction or trouble could cause serious damage to society, person or property.  
If you intend to use the products in the applications listed below or if you have special requirements exceeding the range or conditions set forth in the each catalog, please contact us.

- (1) Aerospace/Aviation equipment
- (2) Transportation equipment (cars, electric trains, ships, etc.)
- (3) Medical equipment
- (4) Power-generation control equipment
- (5) Atomic energy-related equipment
- (6) Seabed equipment
- (7) Transportation control equipment

- (8) Public information-processing equipment
- (9) Military equipment
- (10) Electric heating apparatus, burning equipment
- (11) Disaster prevention/crime prevention equipment
- (12) Safety equipment
- (13) Other applications that are not considered general-purpose applications

When designing your equipment even for general-purpose applications, you are kindly requested to take into consideration securing protection circuit/device or providing backup circuits in your equipment.

# Common Mode Filters

For power line

Product compatible with RoHS directive

Halogen-free

Compatible with lead-free solders

## Overview of ACP3225 Type

### FEATURES

- Chip type common mode filter for DC power supply lines.
- Can reduce power consumption and improve EMC suppression because of low direct current resistance and excellent common mode impedance.
- Compatible with high-density portable devices, which are always being made smaller and lighter, because the height has been reduced.

### APPLICATION

- Power line noise countermeasure for various electronic equipment.
- Noise countermeasure for AC adapter lines and battery lines for note book PCs, portable game machines, and mobile phones.

### PART NUMBER CONSTRUCTION

ACP	3225	-	102	-	2P	-	T	-	<input type="checkbox"/> <input type="checkbox"/> <input type="checkbox"/>
Series name	LxWxH Dimensions (mm)		Impedance ( $\Omega$ ) at 100MHz		Number of lines		Packaging style		Internal code
	3225	3.2x2.5x1.9	102	1000	2P	2 lines	T	$\phi$ 180mm reel	
							TL	$\phi$ 330mm reel	

### OPERATING TEMPERATURE RANGE, PACKAGE QUANTITY, PRODUCT WEIGHT

Type	Temperature range		Reel diameter (mm)	Package quantity (pieces/reel)	Individual weight (g)
	Operating temperature (°C)	Storage temperature* (°C)			
ACP3225	-40 to +85	-40 to +85	$\phi$ 180	1,000	60
			$\phi$ 330	5,000	

\* The Storage temperature range is for after the circuit board is mounted.

- RoHS Directive Compliant Product: See the following for more details related to RoHS Directive compliant products. <http://product.tdk.com/en/environment/rohs/>
- Halogen-free: Indicates that Cl content is less than 900ppm, Br content is less than 900ppm, and that the total Cl and Br content is less than 1500ppm.

 Please be sure to request delivery specifications that provide further details on the features and specifications of the products for proper and safe use. Please note that the contents may change without any prior notice due to reasons such as upgrading.

# ACP3225 Type

## RECOMMENDED REFLOW PROFILE

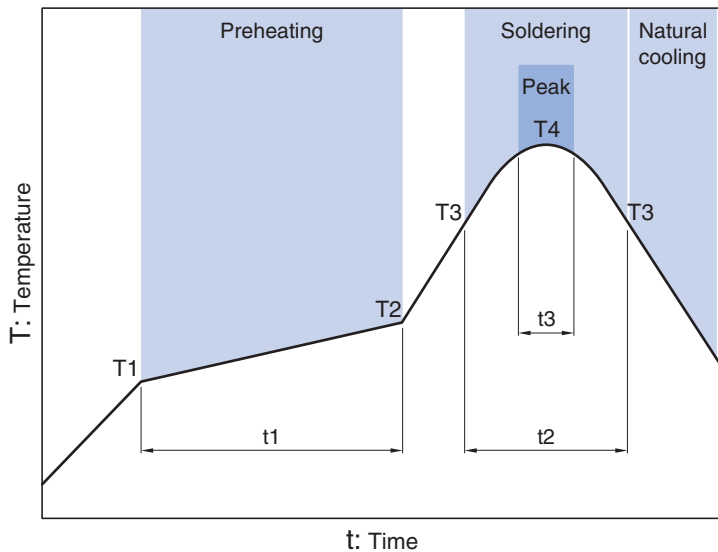

Preheating			Soldering		Peak	
Temp.	Temp.	Time	Temp.	Time	Temp.	Time
T1	T2	t1	T3	t2	T4	t3
150°C	180°C	60 to 120s	230°C	10 to 30s	245°C	5s max.

 Please be sure to request delivery specifications that provide further details on the features and specifications of the products for proper and safe use. Please note that the contents may change without any prior notice due to reasons such as upgrading.

# ACP3225 Type

## SHAPE & DIMENSIONS

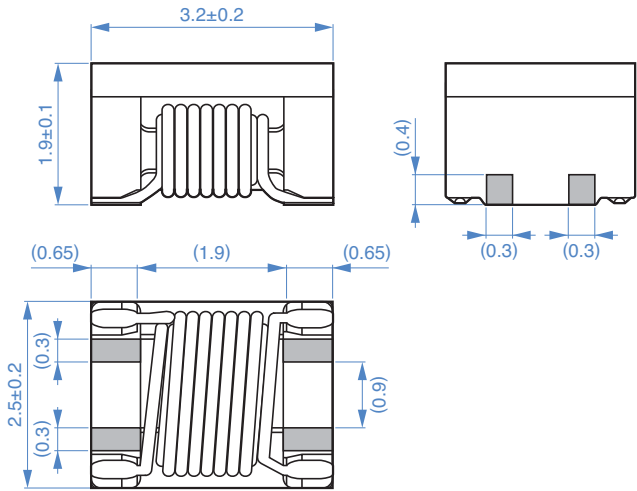

Dimensions in mm

## RECOMMENDED LAND PATTERN

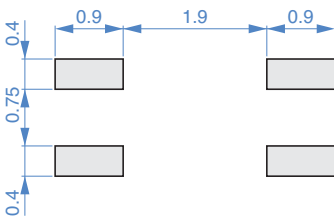

Dimensions in mm

## CIRCUIT DIAGRAM

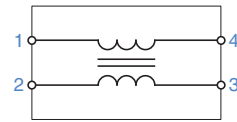

• No polarity

 Please be sure to request delivery specifications that provide further details on the features and specifications of the products for proper and safe use. Please note that the contents may change without any prior notice due to reasons such as upgrading.

# ACP3225 Type

## ELECTRICAL CHARACTERISTICS

### CHARACTERISTICS SPECIFICATION TABLE

Common mode impedance [at 100MHz]		DC resistance	Rated current*	Rated voltage	Insulation resistance	Part No.**
( $\Omega$ )	Tolerance	(m $\Omega$ )typ.	(A)max.	(V)max.	(M $\Omega$ )min.	
1000	$\pm 25\%$	50	1.5	60	10	ACP3225-102-2P- $\triangle$ □□□
500	$\pm 25\%$	40	2	60	10	ACP3225-501-2P- $\triangle$ □□□

\* Temperature derating was considered for the rated current.

\*\*  $\triangle$  : Includes packaging style indication (T:  $\phi$ 180mm reel, TL:  $\phi$ 330mm reel).

#### Measurement equipment

Measurement item	Product No.	Manufacturer
Common mode impedance	4991A	Agilent Technologies
DC resistance	4338A	Agilent Technologies
Insulation resistance	4339A	Agilent Technologies

\* Equivalent measurement equipment may be used.

### TEMPERATURE CHARACTERISTICS (DERATING)

#### ACP3225-102-2P

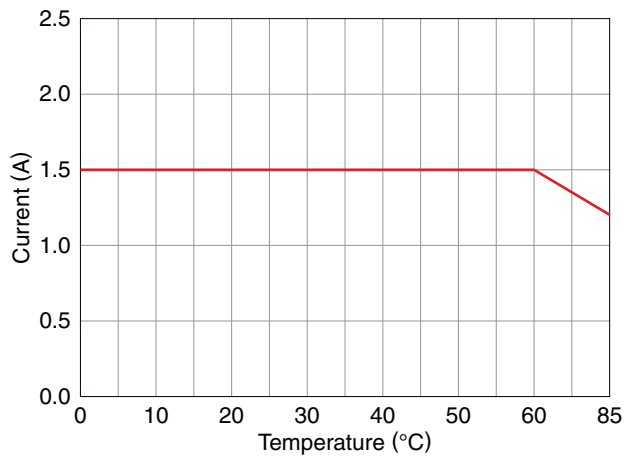

#### ACP3225-501-2P

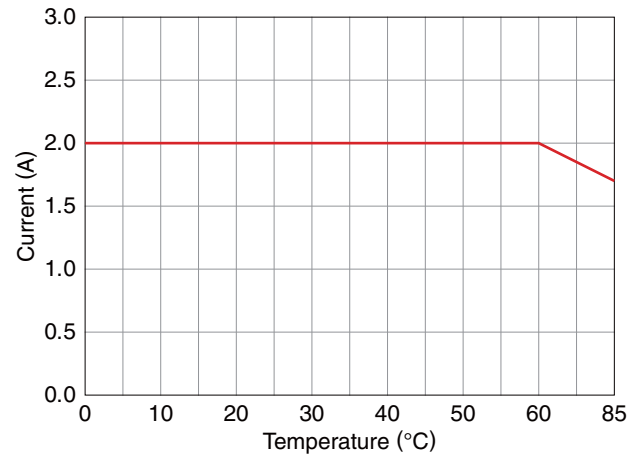

 Please be sure to request delivery specifications that provide further details on the features and specifications of the products for proper and safe use. Please note that the contents may change without any prior notice due to reasons such as upgrading.

# ACP3225 Type

## ELECTRICAL CHARACTERISTICS

### IMPEDANCE VS. FREQUENCY CHARACTERISTICS

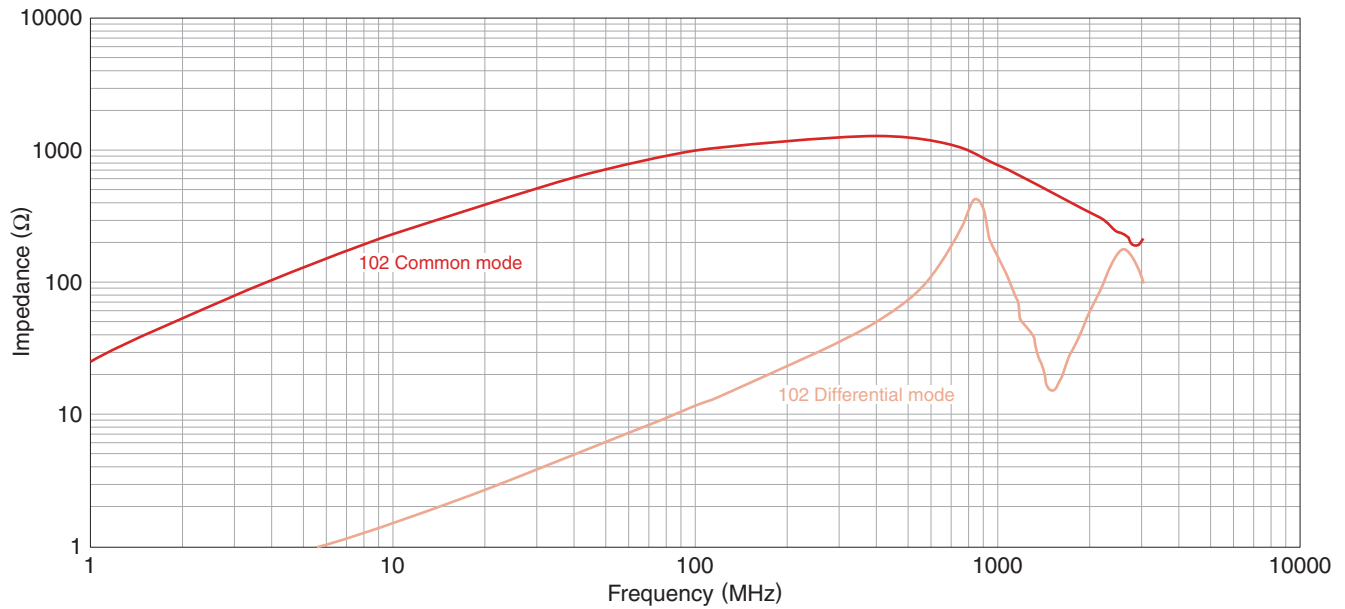

○ Measurement equipment

Product No.	Manufacturer
4991A	Agilent Technologies

\* Equivalent measurement equipment may be used.

# ACP3225 Type

## PACKAGING STYLE

### REEL DIMENSIONS

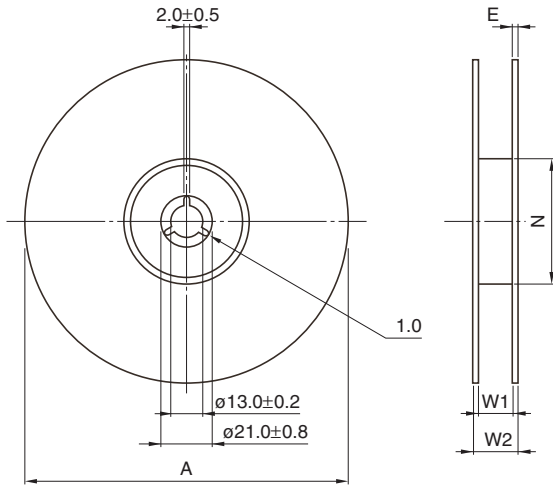

Dimensions in mm

Type	A	W1	W2	N	E
ACP3225	$\phi 330 \pm 2$	$9.5 \pm 0.5$	$13.5 \pm 1$	$100 \pm 1$	2 typ.
	$\phi 180 \pm 3$	$9 + 1 / - 0$	$13 \pm 1$	$60 + 1 / - 0$	2 typ.

### TAPE DIMENSIONS

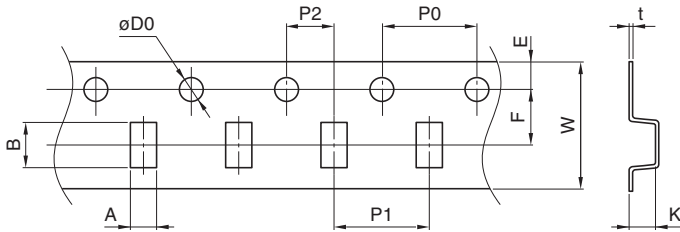

Dimensions in mm

Type	A	B	$\phi D0$	E	F	P0	P1	P2	W	K	t
ACP3225	$2.90 \pm 0.1$	$3.60 \pm 0.1$	$1.5 + 0.1 / 0$	$1.75 \pm 0.1$	$3.50 \pm 0.1$	$4.0 \pm 0.1$	$4.0 \pm 0.1$	$2.0 \pm 0.1$	$8.00 \pm 0.1$	2.35	$0.25 \pm 0.05$

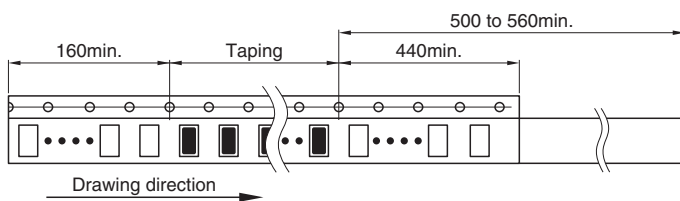

Dimensions in mm

Please be sure to request delivery specifications that provide further details on the features and specifications of the products for proper and safe use. Please note that the contents may change without any prior notice due to reasons such as upgrading.